

Assembly Instructions

Model : B600

Parts Description

CAUTION : Because the edges of some unassembled parts may be sharp, please handle all parts with extreme care.

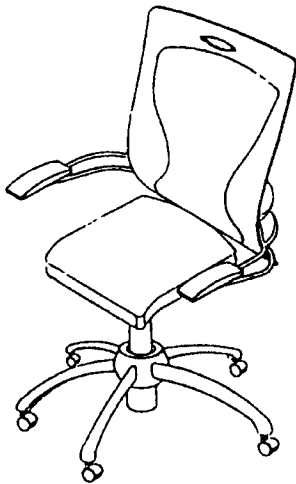

①	②	③	④	⑤	
1 PC	1 PC	1 PC	1 PC	1 PC	
⑥	⑦	⑧	⑨	⑩	⑪
1 PC	1 PC	1 PC	2 PCS	2 PCS	2 PCS

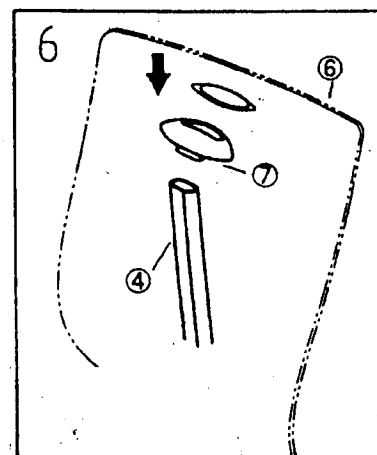
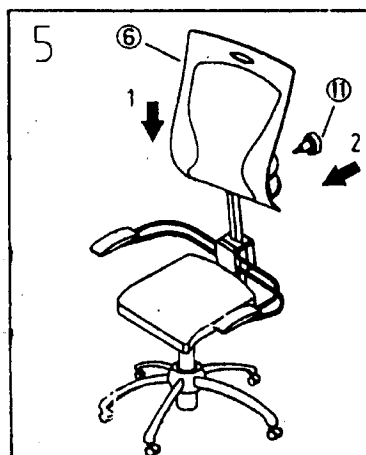
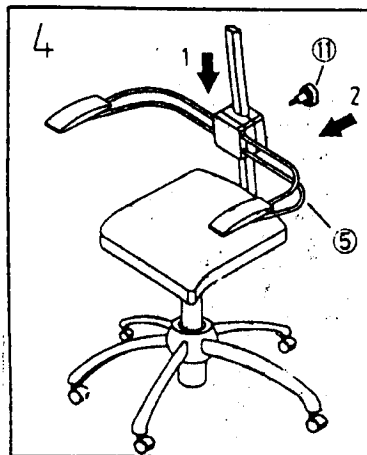
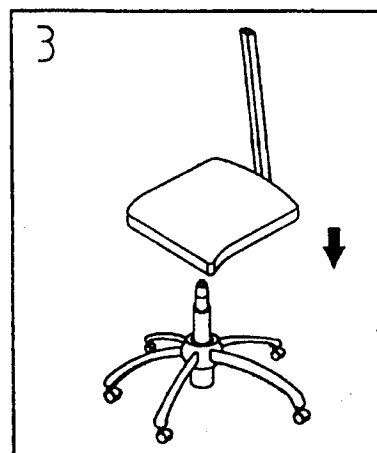
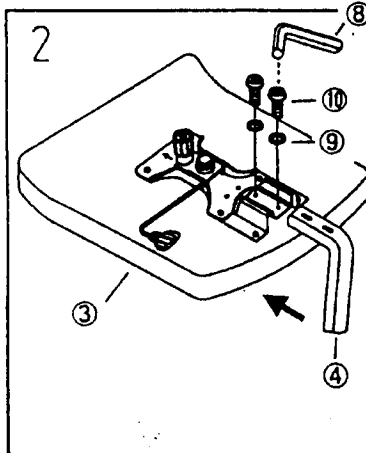
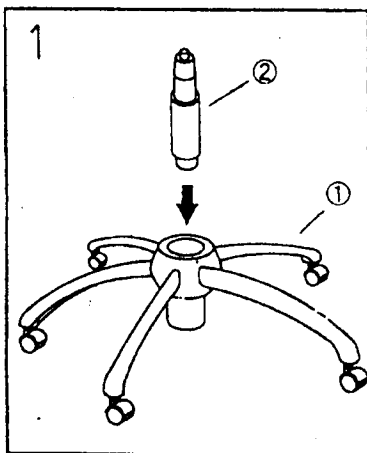

Customer Service Hotline : 1-800-593-1888

Note : Please make sure all screws are completely tightened. It is important to check and tighten all screws every two to three months, or as needed as they may loosen due to normal wear and tear.