

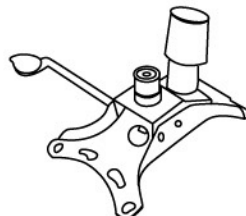



Please unscrew all hardware from cushion before assembly.
Por favor de destornillar todos los tornillos del cojín antes de ensamblar la silla.

MODEL : B9001 B9006 B9151

(1)x1		(2)x1	
		 Mechanism	
(3)x5	(4)x1	(5)x1	
 Caster	 Gas Lift W/ Cover	 Base	
(A)x4		M8X22	MECHANISM SCREWS
(B)x2		M6X30	L-BAR SCREW
(C)x2		M6X22	L-BAR SCREW

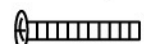
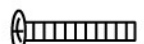
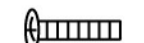
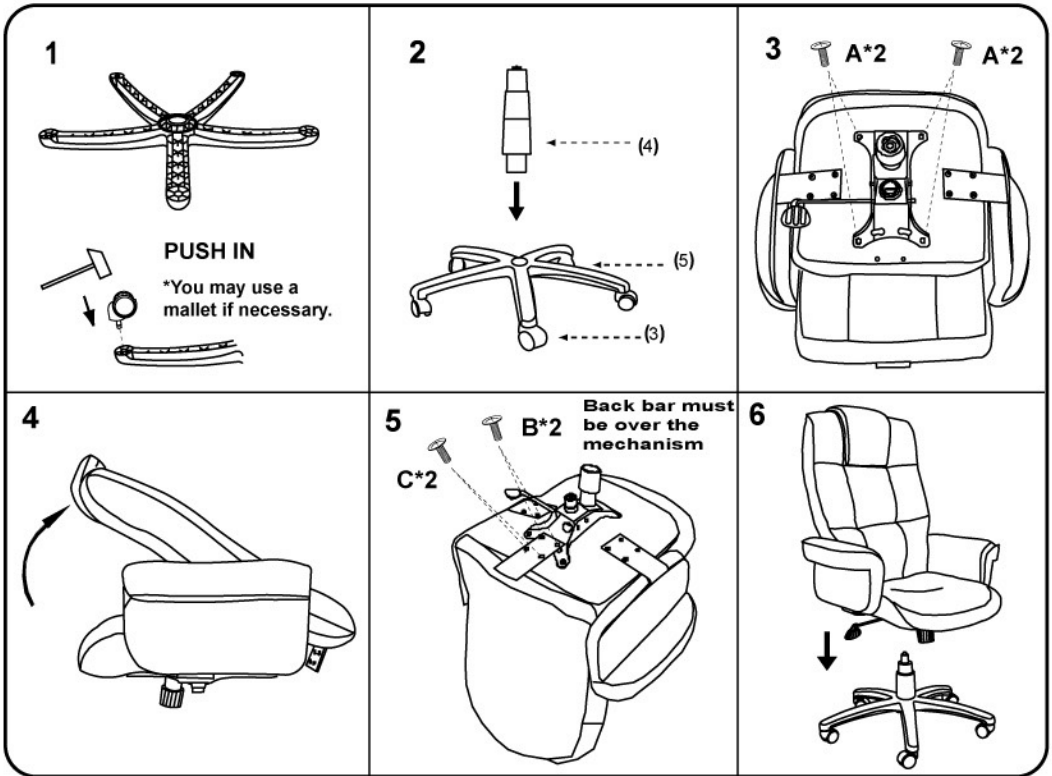

Insert and loosely tighten all screws. When assembly is completed, fully tighten all screws before using. This chair is only intended for sitting. Any other use will void the warranty.

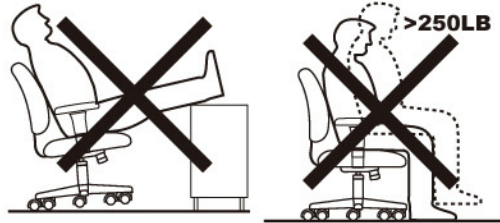

Customer Service Hotline: 1-800-593-1888
For further assembly instructions,
please visit our website at www.bosschair.com